

## Edition

Validated by <sup>1</sup>	Date	Revision	Subject
AG	February 2020	R0	First edition
AG	March 2021	R1	Second edition
MM	January 2022	R2	Third edition
CLR	November 2025	R3	Fourth edition
		R4	

## Conformity of the machine and instructions

For the design of the machine and the drafting of the instructions, the following were consulted:

Reference	Edition	Title
2006/42/EC	2006	Directive 2006/42/EC of the European Parliament and of the Council of 17 May 2006 relating to machinery and amending directive 95/16/EC (redraft)
UNI EN ISO 12100	2010	Safety of machinery – General principles for design – Risk assessment and risk reduction
EN 453	2014	Food processing machinery – Dough mixers – Safety and hygiene requirements

## Warnings for the operator

The descriptions and illustrations annexed to this documentation are not binding.

**ELECTROLUX PROFESSIONAL SPA** reserves the right to make any changes to components, essential parts or supplies that it deems appropriate for the purpose of improvement or for any other need, without undertaking to update this publication.

The reproduction, even partial, and the disclosure of this document, by any means, is not permitted without the author's authorisation.

All reproduction rights in this manual are reserved to **ELECTROLUX PROFESSIONAL SPA**.

This manual cannot be transferred for viewing by third parties without written authorisation from **ELECTROLUX PROFESSIONAL SPA**.

The text cannot be used in other printed matter without written authorisation from **ELECTROLUX PROFESSIONAL SPA**.

Any infringements will be prosecuted in the ways and within the times established by law.

All the names and brands mentioned in this manual are the property of their respective manufacturers.

---

<sup>1</sup> The signature of the manager referred to in note 1: validation of the document in DRAFT allows the issue of revision R3 and validates all sections/chapters of this document.

# Table of Contents

Edition.....	5
Conformity of the machine and instructions.....	5
Warnings for the operator.....	5
Table of Contents.....	6
<b>1 General warnings.....</b>	<b>8</b>
1.1 Intended use of the manual.....	8
1.2 How to read the manual.....	8
1.3 Warranty.....	9
1.3.1 General conditions.....	9
1.3.2 Request for warranty interventions.....	9
1.4 Assistance.....	9
<b>2 Safety devices.....</b>	<b>10</b>
2.1 General safety information.....	10
2.1.1 Directive and standards used for the design of the machine.....	10
2.1.2 Operator characteristics.....	10
2.1.3 Personal Protection Equipment (PPE).....	11
2.2 Safety information concerning the machine.....	12
2.2.1 Intended use.....	12
2.2.2 Non-permitted uses.....	12
2.2.3 Conventions and operator work stations.....	12
2.2.4 Safety devices.....	13
2.2.5 Residual risks.....	13
2.2.6 Warning plates.....	14
<b>3 General description and technical data.....</b>	<b>15</b>
3.1 Machine layout.....	15
3.1.1 Variations.....	16
3.2 Technical data.....	17
3.2.1 Model L.....	17
3.2.2 Model LR.....	18
3.3 Environmental limits.....	19
3.3.1 Explosion and/or fire.....	19
3.3.2 Altitude.....	19
3.3.3 Ambient air temperature.....	19
3.3.4 Vibrations and shocks.....	19
3.3.5 Electromagnetic interference.....	19
3.3.6 Noise.....	19
3.3.7 Lighting.....	19
3.3.8 Degree of protection of electrical equipment.....	19
3.3.9 Materials used.....	20
3.3.10 Cleaning of the work environment.....	20
3.4 Time limits.....	20
<b>4. Installation.....</b>	<b>21</b>
4.1 General warnings.....	21
4.2 Transporting the machine.....	21
4.3 Handling.....	21
4.4 Positioning.....	22
4.5 Wiring and connection.....	22
4.5.1 Connection to the electrical power supply.....	22
4.6 Storage.....	23
4.6.1 Storage of the machine in case of long periods of inactivity.....	23
4.6.2 Preservation of the packed machine.....	23
4.6.3 Preservation of the unpacked machine.....	23

<b>5 Description of commands and notifications</b> .....	25
<b>5.1 Control panel</b> .....	25
<b>6 Operation and use</b> .....	27
<b>6.1 Checks and verifications for safe use of the machine</b> .....	27
<b>6.2 Loading the ingredients</b> .....	27
<b>6.3 Operation</b> .....	28
<b>6.4 Removing the mixture</b> .....	28
<b>6.5 Disconnection</b> .....	28
<b>7 Malfunctions</b> .....	29
<b>7.1 Anomaly</b> .....	29
<b>8 Maintenance</b> .....	31
<b>8.1 Warnings</b> .....	31
<b>8.2 Precautions when undertaking maintenance</b> .....	31
<b>8.3 Procedures for putting into maintenance status</b> .....	32
<b>8.4 Periodic maintenance</b> .....	32
<b>8.4.1 Daily checks</b> .....	32
<b>8.4.2 Monthly checks</b> .....	32
<b>8.4.3 Annual controls</b> .....	32
<b>9 Demolition and disposal</b> .....	34

# 1 General warnings

## 1.1 Intended use of the manual

This instruction manual provides detailed information regarding the safety, characteristics, operation, use, maintenance and demolition of the machine called "Spiral machine".

The machine must be used in accordance with what is specified in these instructions: therefore, it is necessary to **read them carefully** before carrying out any operation, without neglecting anything written and illustrated. Compliance with the standards and recommendations mentioned allows the operator to use the machine in the ways and methods permitted by the manufacturer.

If the operator detects discrepancies between what is described in this document and the machine, they must immediately inform the manufacturer, without using the machine: **incorrect or reckless manoeuvres** can be a source of danger to the health of the operator and/or to persons near the machine itself.

The user instructions are an integral part of the machine; it is therefore necessary to keep them in good condition, in a safe place and available to the operator (or to anyone who requests them, provided that they are authorised to use the machine) for the entire production life of the machine.

In the case of sale, rental, concession in use or financial leasing of the machine, the instructions must be attached to it.

These user instructions are prepared in such a way as to contain all the information useful for the correct **training** and **informing** of the operator in order to avoid improper and dangerous use of the machine.

Use of the machine for purposes other than those envisaged, or in any case improper use, therefore prohibited, of the same, invalidates any responsibility of the manufacturer.

Tampering, replacement, or modification not authorised by the manufacturer of one or more parts of the machine and, more generally, any intervention that is not part of the ordinary or extraordinary maintenance, entails the forfeiture of any responsibility of the manufacturer.

This document was originally issued in the Italian language.

In the event of any disputes due to translations, even if carried out by the manufacturer, the reference text will only be the Italian version.

## 1.2 How to read the manual

The instructions are identified by a code (Pg611\_IU0642\_it\_00) and divided into chapters and paragraphs numbered in progressive order. The page numbering shows the number of the chapter to which it belongs and each chapter starts from page 1: in this way the manual can be easily consulted also by separating the various chapters. In addition to the information described by means of words (description of information), the instructions contain symbols, photographic images and drawings.

The photographic images and drawings (called figures) are numbered in progressive order and the number is followed by a brief description of the illustration.

Figure 1-1, where the first 1 is the indication of the chapter and the second 1 is the progression of the figure within the chapter (the next figure will be "Figure 1-2" and so on).

It is of fundamental importance for the operator assigned to operating the machine to know the meaning of the symbols which, in the technical language referring to the machines, are called pictograms.

The pictograms, depending on their shape and colour, can represent:



### HAZARD

triangular pictogram, edged with black on a yellow background and a black graphic symbol.



### PROHIBITION

circular pictogram, bordered in red on a white background and black graphic symbol.



### OBLIGATION

pictogram of circular shape on a blue background and white graphic symbol.

## **1.3 Warranty**

### **1.3.1 General conditions**

1. The equipment warranty is 12 months from the effective delivery date. It is in any case subject to a complaint by registered letter within 8 days from the discovery of any flaws and defects after verification and recognition by the manufacturer.
2. The warranty includes the replacement or repair of the defective part with the exclusion of disassembly, reassembly and shipping costs.
3. The replacement of this part does not entail renewal of the equipment warranty period. The manufacturer therefore remains exempt from any obligation to pay compensation for any reason and the purchaser also waives any request for expenses or damages from third parties due to possible downtime of the equipment.
4. The warranty does not include parts subject to normal wear and tear due to external atmospheric and environmental agents and all faults deriving from failure, insufficient or incorrect maintenance, inexperience of use, improper use, unauthorised or unintended use, modifications or unauthorised repairs and/or tampering.
5. The validity of the warranty is subject to the correct execution of maintenance as described in the "Maintenance" chapter of this manual.
6. The warranty is excluded if the payment conditions are not respected.
7. For the parts supplied by third parties, the warranties that can be exercised with regard to their manufacturers are valid.
8. Any dispute will be presided over by the competent Court.

### **1.3.2 Request for warranty interventions**

Any requests for spare parts or technical interventions under warranty must be reported to the manufacturer or to the authorised dealer immediately when a defect is found which falls within the specifications of the previous paragraph.

Always indicate the type, model and serial number of the equipment when requesting spare parts under warranty or technical interventions under warranty.

Failure to comply with what is prescribed in this manual will waive the manufacturer from any liability in the event of accidents suffered by persons and/or damage to property or equipment malfunctions.

## **1.4 Assistance**

The Technical Assistance Service is provided directly by the authorised dealer.

## 2 Safety devices

### 2.1 General safety information

#### 2.1.1 Directive and standards used for the design of the machine

For the project, reference was made to the following directives:

- Machinery Directive 2006/42/EC
- EMC Directive 2014/30/EU

And to the following harmonised standards:

- UNI EN ISO 12100:2010
- EN 453:2014

#### 2.1.2 Operator characteristics

The operator assigned to use the machine to avoid creating dangerous situations for themselves, for persons exposed in danger areas, for animals or for materials, must have the following characteristics and be aware of the following dictates:

- they must be a physically fit person, in full possession of their mental faculties, aware of and responsible for the dangers that can be generated by using a machine.
- Before carrying out any operation, the employer must provide adequate operator information and training as required by Directive 89/391/EEC.
- The operator in non-optimal psychophysical conditions must not perform operations of any kind with the machine.
- The state of health of the operator assigned to use the machine is very important in order to avoid accidents in the workplace.
- It is considered of fundamental importance to emphasise that the operator who is not in perfect psychophysical conditions can cause serious damage, in addition to themselves, also to persons, animals or material goods present within the work area.
- The operator assigned to installation, operation or maintenance of the machine must not take substances that can alter their physical and mental abilities, (such as medicines, alcohol, drugs etc.).
- If for any reason an operator must, for a certain period of time, take substances that diminish the reactive properties of the human body, they must immediately inform the plant safety manager, who will temporarily suspend them from this task. The entire suspension and rehabilitation procedure must be overseen by adequate medical documentation.
- The operator must not allow non-authorized persons to approach the machine during its operation (as they are not informed of the dangers generated) and must prevent such persons from using it.
- Use of the machine is recommended for operators with a minimum age of 18 years. Use of the machine is prohibited for persons classified as apprentices.









### 2.1.3 Personal Protection Equipment (PPE)

To safeguard the operator's health when using the machine, it is necessary to use (or have available) the PPE (Personal Protection Equipment) mentioned below.

The employer obliges the operator to use the machine with compliant PPE.

Given the lack of knowledge of all the contexts of the operating environment of the machine, it is necessary to underline that the PPE mentioned refers only to the use of the machine: it will be the employer's task to prescribe additional PPE according to the requirements of the production environment.

#### 2.1.3.1 PPE for operators

Table 1: P.P.E. for operators		
Pictogram	Designated operator	Description
	USE INSTALLATION MAINTENANCE	The constant use of <b>safety shoes</b> as prescribed by the current safety standards.
	USE INSTALLATION MAINTENANCE	Hand <b>protection gloves</b> available in case of the manipulation of objects that can cause damage.
	USE INSTALLATION MAINTENANCE	<b>Suitable clothing</b> , such as overalls: the use of clothing with wide sleeves and/or appendages that can be easily snagged by mechanical parts is prohibited.
	USE INSTALLATION MAINTENANCE	<b>Hair collector cap</b> as prescribed by the hygiene standards in food environments.
	USE	<b>Protective mask</b> to protect the operator from inhaling dust.
	INSTALLATION MAINTENANCE	<b>Protective helmet</b> , available, in case of lifting of parts with significant weights.
	MAINTENANCE	The use of <b>dielectric footwear</b> to prevent the dangers that can be generated by direct or indirect contacts.
	MAINTENANCE	Face <b>protection visor</b> when working on electrical parts, especially if live.

## 2.2 Safety information concerning the machine

### 2.2.1 Intended use

The machine was built and tested according to the provisions laid down by directive 2006/42/EC, and is intended exclusively for the mixing of food products for bakeries and pizzerias.



#### **WARNING**

THIS DEVICE HAS BEEN DESIGNED FOR USE IN COMMERCIAL APPLICATIONS, SUCH AS IN A RESTAURANT KITCHEN, WINERY, HOSPITAL OR COMMERCIAL BUSINESS LIKE A BAKERY, BUT NOT FOR INDUSTRIAL FOOD PRODUCTION.

#### **WARNING**

EVERY OTHER USE ASIDE FROM THAT JUST DESCRIBED IS NOT PERMITTED BY THE MANUFACTURER.

### 2.2.2 Non-permitted uses

The following are prohibited:

1. use of the machine in a constructive configuration different from that foreseen by the manufacturer.
2. use of the equipment in places at risk of explosion and/or fire (the equipment is not certified pursuant to Directive 2014/34/EU ATEX);
3. integration within other systems and/or equipment not considered by the manufacturer;
4. use of the machine with the safety devices tampered with or removed;
5. connecting of the machine to energy sources other than those provided by the manufacturer;
6. use of the machine for operations other than those described in the intended use;
7. use of the machine without having read and fully understood the instructions for use and maintenance;
8. use of the machine if not maintained as described in the use and maintenance instruction

### 2.2.3 Conventions and operator work stations

The machine is equipped with an operator station located on the right side where the control panel is installed.

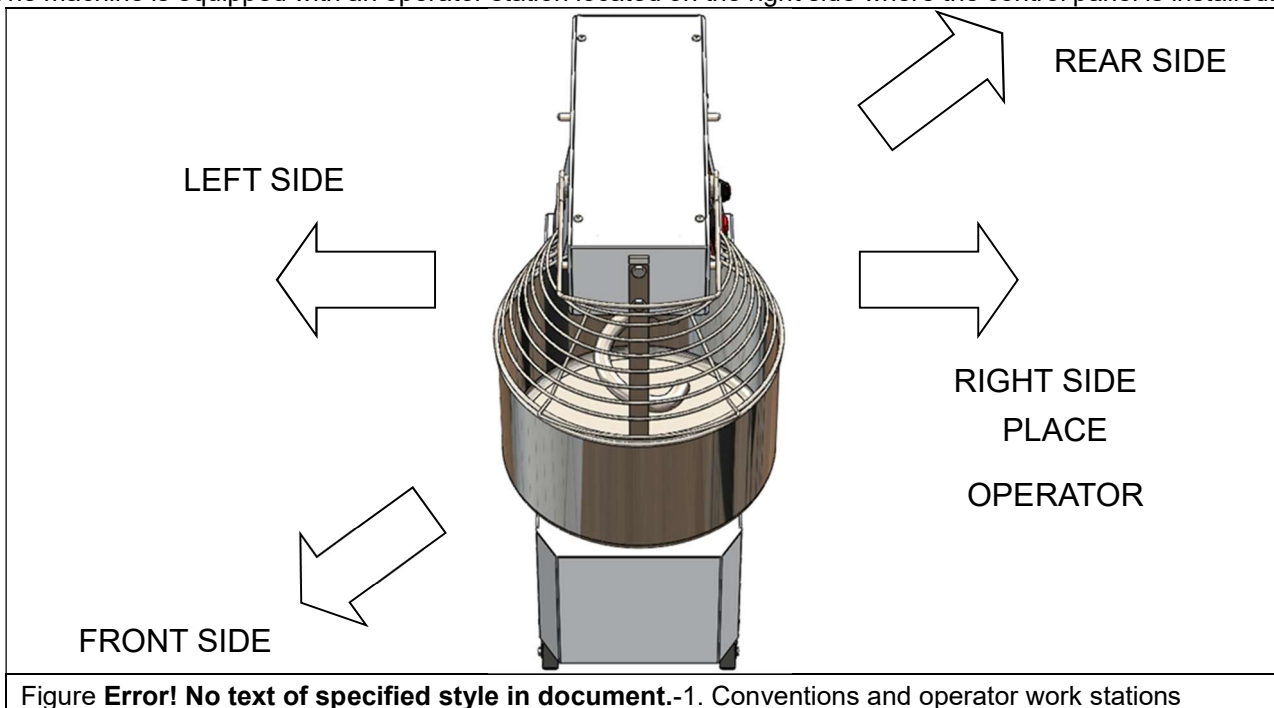

Figure Error! No text of specified style in document.-1. Conventions and operator work stations



## 2.2.4 Safety devices

The safety devices adopted are the following:

- no.1 mobile guard covering the bowl linked to a safety microswitch;
- no.1 fixed guard to protect the spiral movement parts;
- no.1 fixed guard to protect the moving parts of the bowl;
- no.1 fixed guard to protect the dangerous area between the bowl and the machine frame;
- no.1 safety microswitch to supervise the mobile guard covering the segregated bowl inside the machine head;
- no.1 maintained action cycle start button.
- no.1 proximity sensor located between the bowl and the machine frame (only for machine models with the tilting head and the removable bowl, see Figure 3 2).

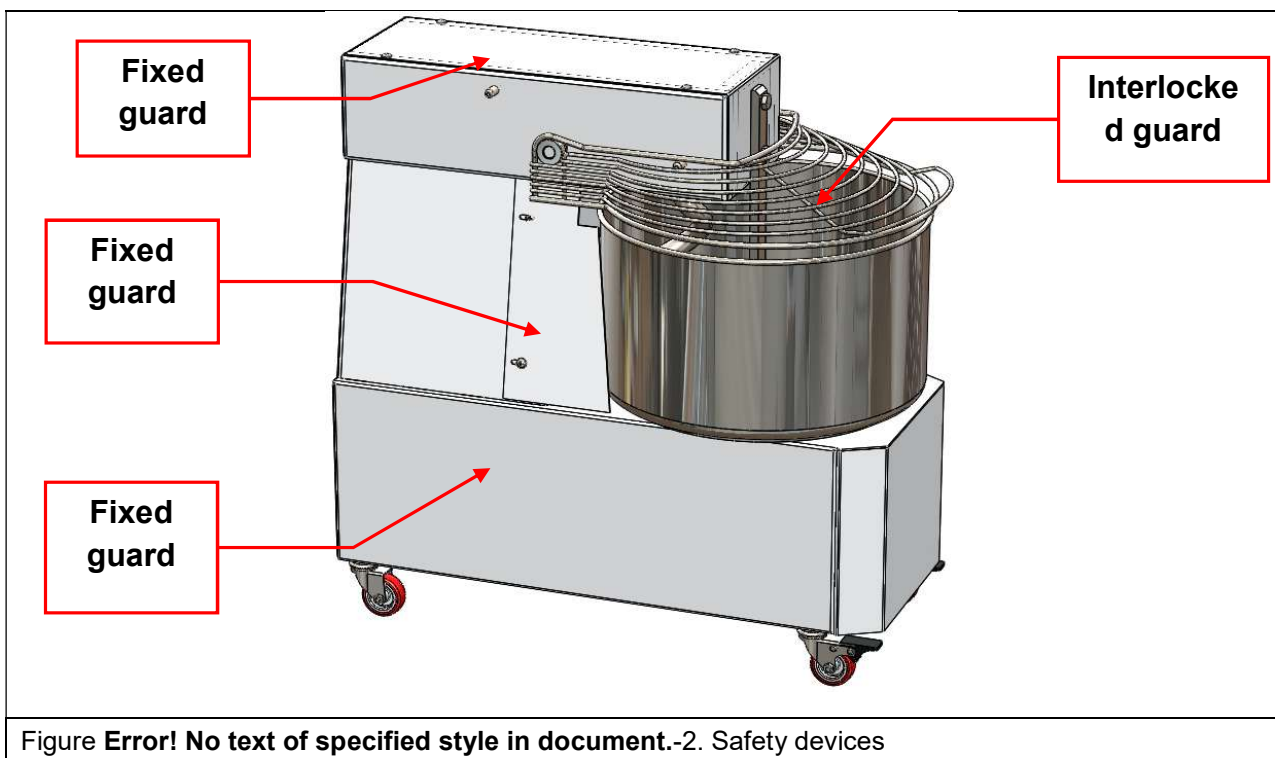

Figure Error! No text of specified style in document.-2. Safety devices

## 2.2.5 Residual risks

From the risk analysis conducted, the residual risk concerning the inhalation of dust from flour was identified. This residual risk was addressed with the obligation of the operator to use a protective mask. Another source of risk can be generated by behaviours that are not permitted by the operator such as for example the failure to use the P.P.E. reported in the paragraph 0. Warning signs for the operator have been applied to the machine shown in Table 2.







## 2.2.6 Warning plates



### **WARNING**

IT IS STRICTLY FORBIDDEN TO REMOVE THE WARNING PLATES PRESENT ON THE MACHINE.

Following the identification of certain residual risks, a series of warning plates was installed on the machine, reported below, in accordance with UNI 7543-1. The Customer is obliged to immediately replace all the warning plates which, following wear, become illegible.

Table 2: Warning plates		
Installed	Description	Position
	<b>Danger of electrocution</b>	On the electrical panel
	<b>Prohibition to remove the safety guards</b>	Visible to the operator
	<b>Prohibition to repair and/or lubricate moving parts</b>	Visible to the operator
	<b>Obligation to consult/read the instructions for use.</b>	Visible to the operator
	<b>Obligation to use a hair collector cap</b>	Visible to the operator
	<b>Obligation to use the protective mask</b>	Visible to the operator
	<b>Obligation to check the efficiency of protective devices</b>	Visible to the operator

### 3 General description and technical data

#### 3.1 Machine layout

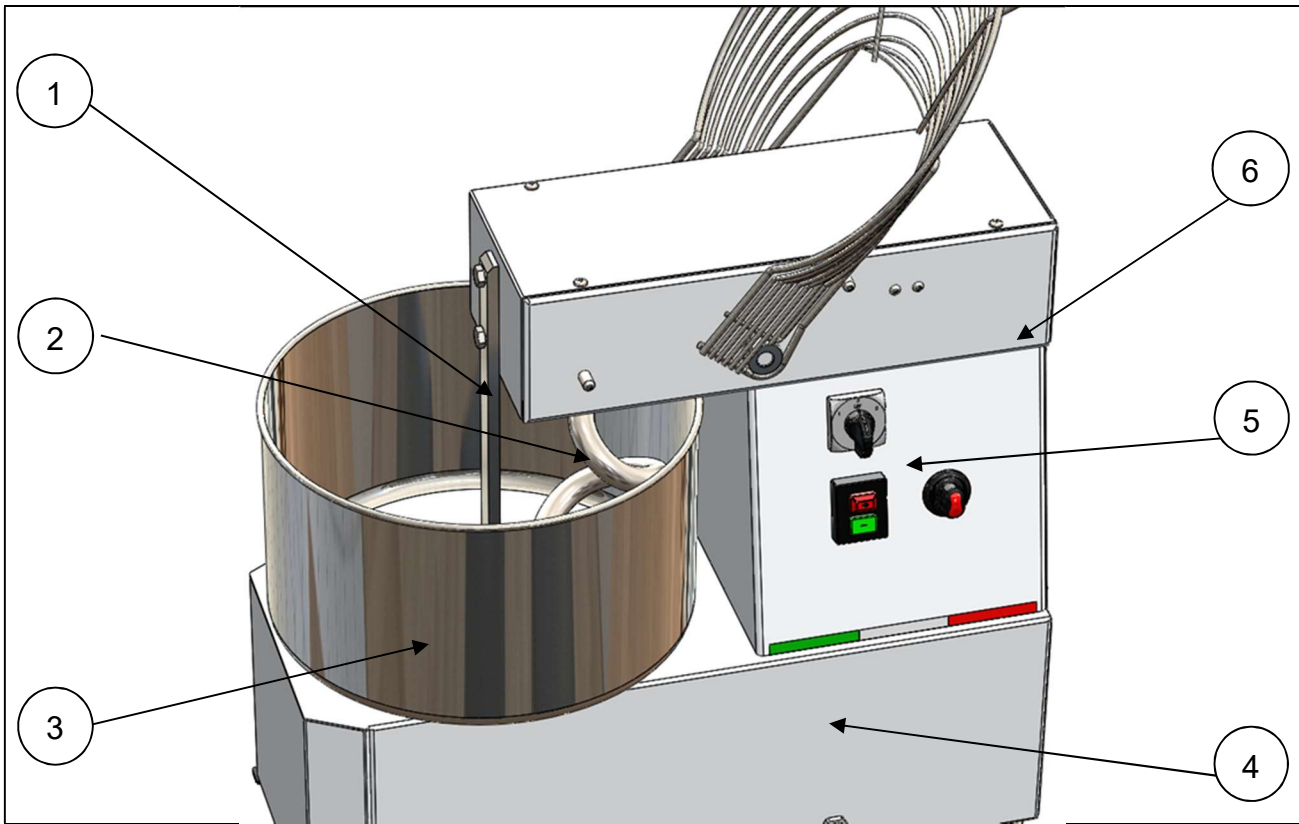

Fig. Error! No text of specified style in document.-3 Machine layout

REF.	PART	DESCRIPTION
1	Column	It facilitates mixing of the contents.
2	Spiral	It mixes and refines the ingredients, pushing them against the column.
3	Bowl	It contains the ingredients to be mixed.
4	Base	It contains the bowl movement parts.
5	Control panel	Operator commands for use of the machine.
6	Head	It contains the spiral movement parts.

### 3.1.1 Variations

The LR22 / LR33 / LR42 models include mixers with a tilting head and a removable bowl that are equipped with three additional components:

- A metal disc, if turned clockwise (UNLOCK) allows the bowl to be removed.
- Handles (one on each side) that, if rotated, allow the head to tilt.
- A proximity sensor located between the bowl and the machine frame that prevents rotation of the spiral with the bowl removed.

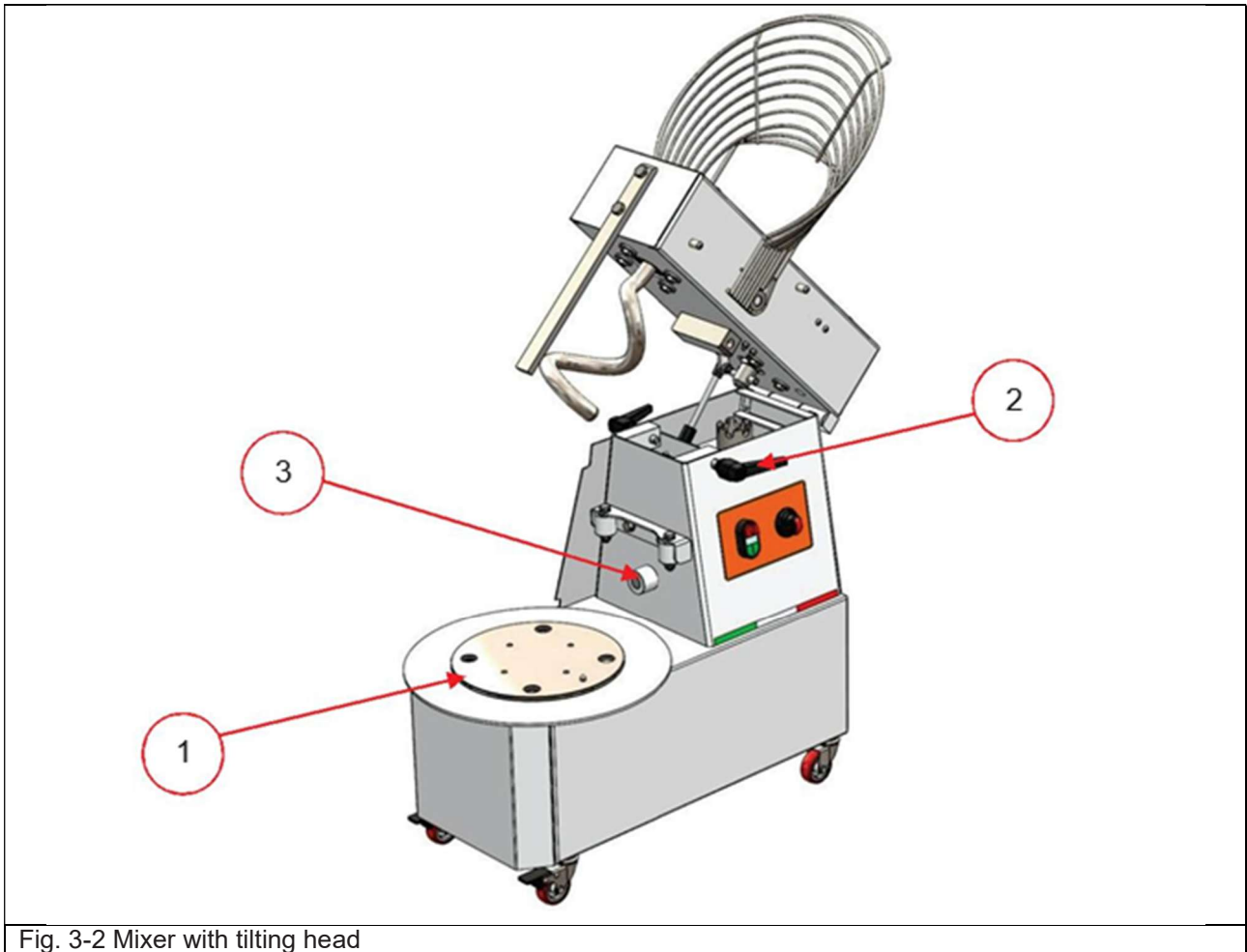

Fig. 3-2 Mixer with tilting head

REF.	PART	DESCRIPTION
1	Disc	Allows the bowl to be removed.
2	Handle	Allows tilting of the mixer head.
3	Proximity sensor	It detects the presence of the bowl.

## 3.2 Technical data

### 3.2.1 Model L

MODELLO	L10			L22			L33			L42			L53			L62		
	230V M.	400V T.	400V T. 2V	230V M.	400V T.	400V T. 2V	230V M.	400V T.	400V T. 2V	230V M.	400V T.	400V T. 2V	230V M.	400V T.	400V T. 2V	230V M.	400V T.	400V T. 2V
VERSIONE																		
VELOCITA' VASCA - RPM	10	10	10	10	10	10	10	10	10	10	10	10	10	10	10	10	10	10
VELOCITA' SPIRALE - RPM	88	97	180	97	180	180	97	180	97	180	180	97	180	97	180	97	180	180
CONSUMO - KW	0,37	0,75	0,75	1,1	1,1	1,1	1,1	1,1	1,5	1,5	2,2	1,8	1,8	1,8	2,2	1,8	1,8	2,2
POTENZA - HP	0,5	1	1	1,5	1,5	1,5	2	2	2	2	3	2,5	2,5	2	3	2,5	2,5	3
ASSORBIMENTO - A	3	4,9	2	2	3	7,3	3	3	9,6	3,3	3,3	4,5	11	4,5	11	4,4	4,4	4,5
CAPACITA' VASCA - L	10		22								42							62
PESO MAX PASTA - KG	8		17								33							50
DURATA CICLO IMPASTO - MIN	14		12\14								12\14							12\14
DIMENSIONI MACCHINA - CM L*P*H (RUOTE COMPRESSE)	30 * 55 * 62		40 * 70 * 68								45 * 74 * 73							56 * 88 * 83
PESO NETTO - KG	41		65								70							97
DIMENSIONI IMBALLO - CM L*P*H	36 * 72 * 71		47 * 79 * 77								51 * 83 * 81							62 * 96 * 88
CBM - M³																		
PESO LORDO - KG	47		75								81							113

Fig. Error! No text of specified style in document.-4. L Technical data

### 3.2.2 Model LR

MODEL	LR22				LR33				LR42			
	230/1	400/3	400/3		230/1	400/3	400/3		230/1	400/3	400/3	
volt (V)			1*VEL	2*VEL			1*VEL	2*VEL			1*VEL	2*VEL
Bowl speed (rpm)	10	10	10	20	10	10	10	20	13	13	13	26
Spiral speed (rpm)	84	84	84	168	84	84	84	168	84	84	84	168
Power (kW)	0,75	0,75	0,75	1,1	1,1	1,1	0,75	1,1	1,5	1,5	1,5	2,2
Power (hp)	1	1	1	1,5	1,5	1,5	1	1,5	2	2	2	3
Amperè (A)	4,9	2	2	3	7,3	3	2	3	9,6	3,3	3,3	4,5
Bowl capacity (L)		22				33				42		
Dough capacity (kg)		17				25				33		
Dough cycle (min)		12 - 14				12 - 14				12 - 14		
Net sizes (cm- l*p*h)		40*70*70				45*74*75				51*84*80		
Net weight (kg)		79				87				112		
Gross sizes (cm- l*p*h)		47*79*77				51*83*81				57*90*83		
Gross weight (kg)		89				98				125		

Figure 3-4. LR Technical data

### 3.3 Environmental limits

Unless otherwise specified in the contract, it is understood that the machine can function properly only in the environmental conditions referred to in the following points. Environmental conditions other than those prescribed may cause malfunctions or breakages with consequent dangerous situations for the health of the operator and of any exposed persons.

**It is the task of the production plant manager to verify that these conditions are always met.**

#### 3.3.1 Explosion and/or fire

The machine was not designed to be used in places where substances in the form of a cloud of dust can cause an explosive atmosphere with air.



#### **EXPLOSION AND/OR FIRE HAZARD**

THE MACHINE MUST NOT BE USED IN AREAS WITH EXPLOSION HAZARD OR RISK OF FIRE.

#### 3.3.2 Altitude

The machine is able to function properly at altitudes of up to **1000 meters** above sea level.

#### 3.3.3 Ambient air temperature

The electrical equipment works correctly at air temperatures of between **+5°C** and **+40°C**.

The electrical equipment is able to function properly when the relative humidity does not exceed **50%** at a maximum temperature of **+40°C**. Higher relative humidity levels are permitted at lower temperatures.

#### 3.3.4 Vibrations and shocks

The machine must be installed on surfaces that do **NOT** transmit vibrations and in environments where there is **NO** danger of impact with other mechanical assemblies.

#### 3.3.5 Electromagnetic interference

The machine in question in this manual has been designed to operate correctly in an electromagnetic environment of an industrial type.

#### 3.3.6 Noise

The noise emission of the machine during normal operation is less than **70 dB**.

#### 3.3.7 Lighting

The plant's lighting system is to be considered important for the safety of persons. The installers of the lighting system must comply, within the EEA, with the minimum requirement set by the UNI EN 12464-1 standard, relating to the natural and artificial lighting of premises. The minimum lighting must be such as to guarantee the **correct perception** of symbols and marks.

The lighting level must always be such as to guarantee operation in the maximum possible safety.

The **installation** operations must be carried out in "normal" light conditions, that is, such as not to dazzle the operator's vision and not to strain it in case of low light.

Use battery lighting devices or devices installed on columns and connected to the plant's electricity supply network. Do not aim the auxiliary lighting devices directly towards the operator's eyes in order to avoid dazzling them.

#### 3.3.8 Degree of protection of electrical equipment

The degree of protection with regard to the motor casings is IP23.

The degree of protection with regard to the enclosures of the control equipment is IP22.

### 3.3.9 Materials used

The metallic materials that come into contact with food have been examined and comply with regulation 1935/2004.

### 3.3.10 Cleaning of the work environment

the machine can only be used in environments suitable for storing and producing food. It is also necessary to respect the following operating conditions:

- absence of ventilation during loading of the ingredients and during the initial phase of the work cycle (mixing of the ingredients) in order to prevent the excessive emissions of food dust;
- the use of containers and utensils suitable for the treatment of food products.



#### **HAZARD**

THE DEVICES MUST NOT BE CLEANED WITH WATER JETS OR STEAM CLEANERS

### 3.4 Time limits

The expected life of the machine is 10 years.



## 4. Installation

### 4.1 General warnings

The operator assigned to installing the machine must be a person who is adequately trained and informed about the work they are preparing to undertake.

The operator must use suitable means to safely carry out the installation operations: therefore, it should be remembered that all the equipment used for the installation must be in a perfect condition and must be used as provided by the respective manufacturers.

The choice of the place or spaces is important for the quality of the work (maintenance, safety, etc.): this area must be well lit and ventilated.

The environmental and operating conditions must not constitute an obstacle for access to the controls.

Before starting to handle of the machine, it is necessary to check:

- the efficiency of the lifting equipment;
- the capacity of the same. For the lifting of machines or parts of it, means having a minimum capacity greater than the declared weight are required;
- the characteristics (weight, size, etc.) of the machine indicated in the paragraph 0.
- this device must be connected with flexible connections that follow for easy equipotential bonding and connection to utilities such as electricity, water, gas and steam, so that the device can be moved in the required direction for cleaning by a distance no less than the size of the device in the direction of movement plus 50mm, without the flexible connections being stretched or subjected to stress.



#### **WARNING**

THE MACHINE MUST BE PLACED IN A COVERED AREA PROTECTED FROM DIRECT CONTACT WITH ATMOSPHERIC AGENTS.

### 4.2 Transporting the machine

The machine can be shipped by truck, container or in rare cases by air.

The packaging consists of a cardboard box containing the machine on wooden pallets.

The dimensions and gross weight of the packed machines are shown in Fig. Error! No text of specified style in document.-4.

### 4.3 Handling

Machine handling operations must be carried out by trained personnel (harnessers, forklift drivers, crane operators, etc.).



#### **WARNING**

FOR TRANSPORTATION OF THE MACHINES, VEHICLES WITH A MINIMUM CAPACITY HIGHER THAN THE DECLARED WEIGHT OF THE SAME ARE REQUIRED (SEE PARAGRAPH 0). BEFORE STARTING HANDLING, IT IS NECESSARY TO CHECK THE EFFICIENCY OF THE LIFTING MEANS AND THEIR CAPACITY.

The packed machine is moved by means of a transpallet by inserting the forks on the pallet making sure that they protrude from the pallet itself.

The unpacked machine is manually moved by the operator by pushing or dragging as the machine is equipped with 4 wheels, 2 of which are on the front with a mechanical brake device.

## 4.4 Positioning

The machine must be handled as indicated in the paragraph 0

When positioning the machine, check:

- that the floor is smooth, flat and resistant enough to allow the machine to rest safely;
- using a centesimal levelling device, check that the machine is level;
- that there is sufficient space around the machine to comply with the minimum recommended distance of 800 mm from the surrounding walls;
- that the machine is positioned near an adequate power supply;
- that the operator can easily load the ingredients and remove the mixture;
- that there is sufficient space around the machine for easy cleaning and maintenance;
- that the two front wheels are locked by the mechanical brake device.

## 4.5 Wiring and connection

### 4.5.1 Connection to the electrical power supply

Refer to the technical data shown in the paragraph 0 for connecting of the machine to the power supply.

Connection of the machine to the electrical network must be carried out by specialist personnel, in compliance with the good technical and safety standards in force.

It is essential to connect the machine to an efficient and controlled earthing network.

**If in doubt about the efficiency of the network, do not connect the machine.**

The user is required to provide an adequate disconnecter for the power line upstream of the machine, as well as effective means of protection against overcurrents and indirect contacts.

Effective means of protection against overcurrents can be represented by:

- fuses,
- automatic switches,
- magnetothermic switches.

Effective means of protection against direct contacts, instead, can be represented by:

- differential switches,
- fault sensors.

When connecting, check:

- that the voltage of the power supply corresponds to the voltage and frequency indicated in the wiring diagram annexed to the machine (an incorrect supply voltage can damage the machine);
- that the power supply network is equipped with an adequate earthing system;
- the power supply network must have a system impedance lower than 0.224Ohm, in accordance with standard IEC 61000-3-11:2017;
- the correct position and fixing of the microswitches;
- that the direction of rotation of the bowl is correct, i.e. clockwise seen from above (as indicated on the label applied on the bowl). If the direction of rotation of the bowl is not correct, it is necessary to invert the two wires of the power supply cable on the electrical box of the machine in order to correct the direction of rotation.



#### **WARNING**

IF THE POWER CABLE IS DAMAGED, IT MUST BE REPLACED BY THE MANUFACTURER, A TECHNICIAN, OR A QUALIFIED PERSONNEL TO AVOID HAZARDS.

**WARNING**

ALL PARTS OF THE MACHINE ARE SEATED TO THE SAME POTENTIAL THROUGH THE "EQUIPOTENTIAL BONDING TERMINAL". ENSURE THAT THIS SYMBOL IS PRESENT INSIDE THE CASING.

**WARNING**

THREE PHASE MIXERS ARE SUPPLIED WITHOUT SUPPLY PLUG OR A CURRENT DISCONNECTION DEVICE. IT IS USER'S RESPONSIBILITY TO PROVIDE ONE OF THE FOLLOWING CONFIGURATIONS:

- A DISCONNECTION DEVICE IN COMPLIANCE WITH CEI 60947-2;
- A PLUG IN COMPLIANCE WITH CEI 60309-1

## 4.6 Storage

### 4.6.1 Storage of the machine in case of long periods of inactivity

- Disconnect the machine from the power supply.
- Clean the machine thoroughly as described in the paragraph 2.
- Protect the machine from atmospheric agents, dust and dirt.

### 4.6.2 Preservation of the packed machine

The machine must be stored in a hygienically clean, closed and covered environment, positioned on a flat and solid surface and protected from atmospheric agents, dust and dirt.

The ambient temperature must be between  $-20$  and  $+40^{\circ}\text{C}$ , while the humidity of the environment must not be higher than 90%.

### 4.6.3 Preservation of the unpacked machine

Once the machine is unpacked, in addition to implementing the conditions specified above, it must also be lifted from the ground (on a suitable pallet or other stable platform) and carefully covered to protect it against humidity, dust and dirt. If the machine is wrapped in cellophane or other type of plastic, it is absolutely essential to make sure that it is not hermetically sealed, in order to avoid corrosion due to condensation. If possible, keep the original packaging.

**WARNING**

STORAGE OF THE MACHINE WITHOUT A COVERING IS ABSOLUTELY FORBIDDEN.



## 5 Description of commands and notifications

### 5.1 Control panel

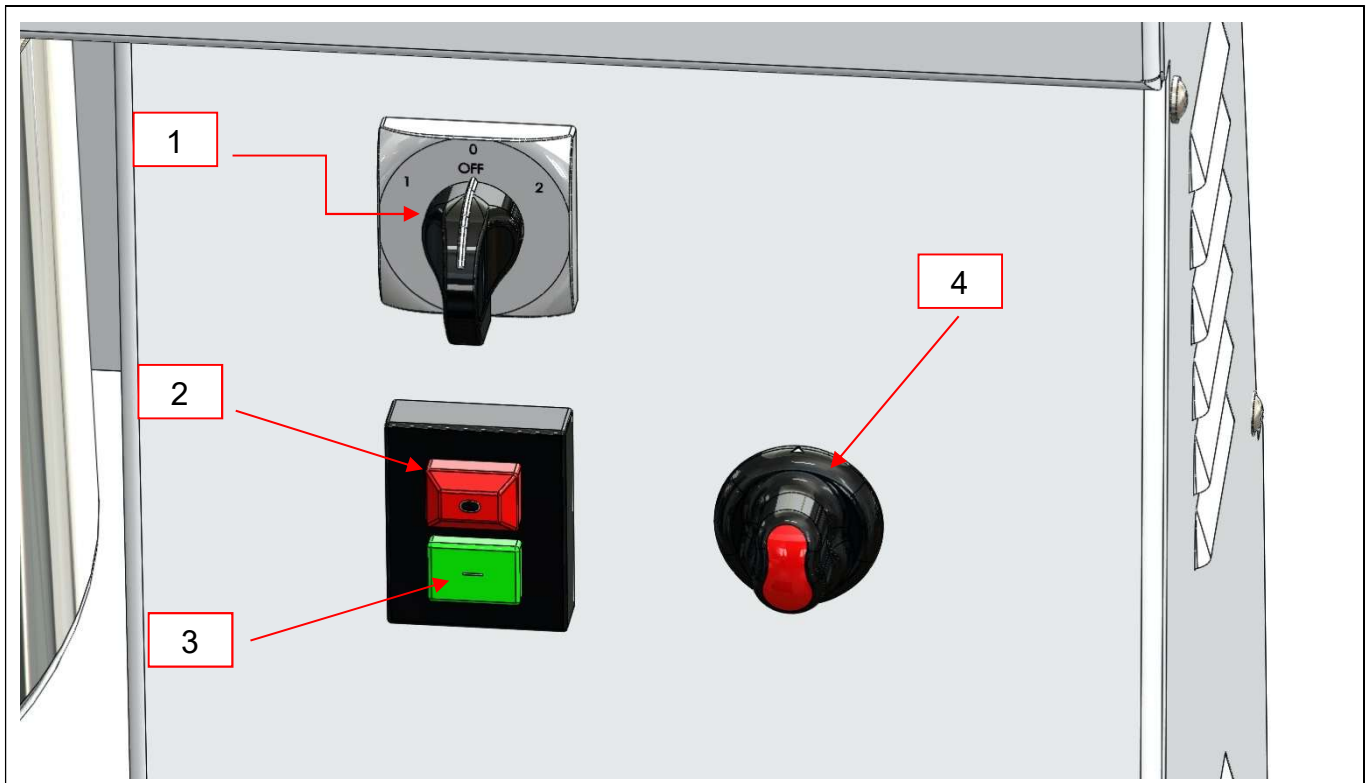

Fig. Error! No text of specified style in document.-5 Type 1

REF.	CONTROL	COLOUR	FUNCTION
1	Selector <b>SPEED</b>	//	Three-position selector that is used to adjust the rotation speed of the bowl and of the spiral. 1: Minimum speed. OFF: Machine stopped. 2: Maximum speed.
2	Button <b>STOP</b>	Red	If pressed it stops the mixing cycle.
3	Button <b>START</b>	Green	If pressed, it starts the mixing cycle at the selected speed.
4	Knob <b>CYCLE TIMER</b>	//	Timer for setting of the cycle time in minutes. If the arrow points to the hand, the cycle starts without a timer.



#### WARNING

THE CONTROL PANEL IS AVAILABLE IN TWO DIFFERENT CONFIGURATIONS:  
1: WITHOUT THE SPEED SELECTOR.  
2: WITHOUT THE SPEED SELECTOR AND WITHOUT THE CYCLE TIMER (MOD. L10).



#### NOTE

FOR THE ADDITIONAL COMMANDS RELATING TO THE LR MODEL, REFER TO PARAGRAPH 3.1.1.



## 6 Operation and use

### 6.1 Checks and verifications for safe use of the machine

Remember that:

- the machine can be used by only one operator at a time;
- the operator must never leave the machine unattended when it is turned on. If it is necessary to leave the workplace, disconnect the machine from the power supply;
- the user must not tamper with or alter the operation or efficiency of the protective devices on the machine;
- the user must possess the characteristics listed in the paragraph 0.

Before starting operations with the machine, on a daily basis, they will have to carry out checks to make sure that all the safety conditions exist to avoid accidents.

To facilitate the operator, we list below the **pre-start checks**.

1. Check that the machine is clean and that the bowl does not contain foreign bodies.
2. Check that the machine is in a stable position on a flat, smooth and solid surface.
3. Check that the machine has been correctly connected to the power supply.
4. Check that the machine is equipped with all the pictograms and warning plates provided.
5. Visually check the general condition of the machine and that there is no damage or conditions of obvious deformation, especially with regard to ageing, wear and fatigue.
6. Check the efficiency of the safety devices. If the machine has been tampered with, **do not use the machine**.

### 6.2 Loading the ingredients



#### WARNING

DO NOT EXCEED THE MAXIMUM PERMITTED QUANTITIES OF THE RESPECTIVE MACHINE MODEL USED REFERRED TO IN THE PARAGRAPH 0.

The recommended sequence for loading of the ingredients is as follows:

1. Pour the required amount of water into the bowl.
2. Pour in the flour (in the correct proportion with respect to the water) by positioning the bag inside the bowl and cutting it with a cutting tool at the bottom in order to avoid the formation of dust clouds.
3. Next, add the other ingredients for the mixture, lifting the movable guard and pouring them into the bowl. If the movable guard is raised while the machine is working, the machine stops; it is therefore necessary to close the movable guard and restart the machine to complete the work cycle by pressing **START**.



#### WARNING

IT IS INADVISABLE TO INTRODUCE THE FLOUR INTO THE BOWL BEFORE THE WATER BECAUSE THIS GENERATES COMPACT MASSES OF HIGH DENSITY FLOUR IN THE MIXTURE THAT COULD CAUSE IRREGULAR MACHINE OPERATION.

## 6.3 Operation

To switch on the machine proceed as follows (refer to chapter 5):

1. follow the procedure given in the paragraph 0;
2. check that the mobile guard is closed;
3. adjust the cycle time using the CYCLE TIMER (if present) or set it towards the hand to proceed with the cycle without a timer;
4. set the speed of the work cycle using the SPEED selector (if present);
5. press the START button to start the processing cycle;
6. the machine stops automatically at the end of the set time, if not if a time has been set for the working cycle, press the STOP button to stop the machine manually.

To best preserve the functionality of the machine, it was defined the follow "TIME ON" and TIME OFF"

- L10 M: TIME ON 20min / TIME OFF 40min.

For the others models of the machine, a "TIME ON" and a "TIME OFF" has not been defined because it is not necessary.

## 6.4 Removing the mixture

To facilitate removal of the mixture, it is possible to keep the START button pressed to operate the machine manually and to allow the operator to rotate the bowl and remove the dough from different positions with the mobile guard open.



### **WARNING**

IT IS FORBIDDEN TO USE ANY TOOL THAT CAN SCRATCH OR DAMAGE THE MACHINE AND MACHINE TOOLS.

## 6.5 Disconnection

When putting the machine out of service, it is advisable to:

1. Disconnect the machine from the electrical system.
2. Clean the machine carefully as indicated in the paragraph 2.
3. Protect the machine from atmospheric agents as indicated in the paragraph 0.



## 7 Malfunctions

### 7.1 Anomaly

Table 3: Anomaly		
Anomaly	Cause	Intervention
The machine is not electrically powered.	The power outlet is not connected to the electrical system.	Connect the plug to the electrical system.
The machine is electrically powered but does not work.	The machine has been connected incorrectly.	Check the electrical connection (paragraph 0).
	A time has not been set for the processing cycle.	Turn the CYCLE TIMER towards the desired time for the processing cycle.
	The movable guard of the bowl is open.	Close the mobile guard of the bowl.
The spiral rotates inconsistently, or the machine makes more noise than usual.	The chain is loose.	Tension the chain as described in the paragraph 0.



## 8 Maintenance

### 8.1 Warnings

The user must set up a system (if this has not already been done) to record all the maintenance work performed.

Failure to record an intervention is to be considered as "maintenance not performed".

All the maintenance information relates only to ordinary maintenance with interventions aimed at the correct daily operation of the machine.

Maintenance must be carried out by the following categories of persons:

- **specialist mechanical maintenance technician:** A qualified technician able to operate the machine in normal conditions, to operate it with the protections disabled, to intervene on the mechanical parts to perform all the necessary adjustments, maintenance and repairs;
- **specialist electrical maintenance technician:** A qualified technician capable of operating the machine in normal conditions and operating it with the protections disabled; they are responsible for all electrical adjustments, maintenance and repairs. They are capable of operating in the presence of voltage.

It is good practice to use only original materials for repairs in order to guarantee the safety of the machine in any case.

Check that the tools available are suitable for use and always avoid the improper use of tools or equipment.

### 8.2 Precautions when undertaking maintenance

Maintenance personnel must be aware that carrying out these operations can cause dangers. It is therefore necessary to comply with all the warnings contained in these user instructions.

The following are essential:

- use the **personal protection equipment**.
- avoid physical contact with moving parts of the machine;
- unqualified and unauthorised personnel must **not** enter the work area of the machine when it is under maintenance;



#### PROHIBITION

PROHIBITION OF ACCESS TO THE WORK AREA OF THE MACHINE FOR NON-QUALIFIED AND UNAUTHORISED PERSONNEL.

- the maintenance operations must be carried out with sufficient lighting; in the case of maintenance located in areas that are not sufficiently illuminated, portable lighting devices must be used, taking care to avoid shadow cones that prevent or reduce the visibility of the point to be worked on or the surrounding areas (follow the instructions in the paragraph 0 "Lighting the operating environment").



#### ELECTRICITY HAZARD

MAINTENANCE OPERATIONS THAT REQUIRE THE PRESENCE OF ELECTRICITY, SUCH AS TROUBLESHOOTING IN THE ELECTRICAL PANEL, **MUST BE PERFORMED ONLY BY QUALIFIED PERSONNEL FOLLOWING THE SAFETY PROCEDURES FOR WORK INSIDE THE SYSTEM WHERE THE MACHINE IS INSTALLED.**



#### CHECK THAT GUARDS AND PROTECTIONS ARE EFFICIENT

THE GUARDS AND SAFETY DEVICES MAY BE REMOVED IN PART OR FULLY DURING MAINTENANCE OPERATIONS BY SPECIALIST AND/OR AUTHORISED PERSONNEL WHO WILL REASSEMBLE THEM IN THE ORIGINAL POSITION AS

SOON AS THE MAINTENANCE OPERATIONS ARE COMPLETE: AT THE END OF THE MAINTENANCE IT IS NECESSARY TO VERIFY THAT THE PROTECTIONS ARE CORRECTLY ASSEMBLED AND EFFICIENT. THE MACHINE CANNOT BE STARTED AFTER A MAINTENANCE INTERVENTION WITHOUT THE PROTECTIONS AND OTHER DEVICES HAVING BEEN REASSEMBLED.

### 8.3 Procedures for putting into maintenance status

Proceed as follows:

1. Follow the instructions in the paragraph 0.
2. Enclose the machine and affix the "MACHINE UNDER MAINTENANCE" sign.

### 8.4 Periodic maintenance

#### 8.4.1 Daily checks

**EACH start of shift.**

1. Efficiency control of the microswitch connected to the movable guard of the bowl.
2. Control operation of the control panel (see paragraph 0).
3. Clean the machine as described in the paragraph 2.
4. Checking the efficiency of the proximity sensor between the bowl and the machine frame.

#### 8.4.2 Monthly checks

At least **ONCE A MONTH:**

1. Check the tension of the upper chain located inside the machine head which must be adjusted when there is a slowdown in the rotation of the spiral or if the rotation movement is not fluid during the execution of a processing cycle by loosening the screws and removing the upper fixed guard. At this point it is necessary to loosen the screws that fix the spiral support by a few turns and to pull the spiral until the chain tension is optimised. Finally lock the spiral support by tightening the screws and reassembling the fixed guard.

At least **ONCE EVERY 6 MONTHS:**

1. Grease the chains located inside the head and inside the base of the machine by loosening the screws that lock the fixed guard to protect the head and the fixed guard located behind the machine; deposit within the chains a reasonable amount of suitable and sufficient grease to ensure the lubrication of all the links of the chains; when the operation is completed, reassemble the two fixed guards.



#### **WARNING**

CHAIN LUBRIFICATION MUST BE PERFORMED BY A SPECIALIZED TECHNICIAN TRAINED BY THE MANUFACTURER.

#### 8.4.3 Annual controls

At least **ONCE EVERY 5 YEARS:**

1. Provide for the replacement of the safety microswitch to protect the front mobile guard located inside the head cover of the machine as, following the analysis of the performance level carried out, it has been found that the device no longer guarantees an adequate level of reliability.

At least **ONCE EVERY 10 YEARS:**

2. Provide for the replacement of the switch block consisting of the protective START and STOP button which guarantees the safety function of the control with maintained action as, following the analysis of the performance level carried out, it has been found that the device no longer guarantees an adequate level of reliability.

#### 8.4.4 Cleaning the machine



##### **PROHIBITION**

IT IS FORBIDDEN TO CLEAN THE MACHINE IN A WAY OTHER THAN AS INSTRUCTED BY THE MANUFACTURER.

ELECTROLUX Professional NO LIABILITY IS ASSUMED FOR ANY DAMAGE TO THE MACHINE FOR FAILURE TO COMPLY WITH THE RECOMMENDATIONS CONTAINED IN THIS DOCUMENTATION.

The machine has been designed for the production of food products and it is therefore essential that it is cleaned and sanitised thoroughly every day, according to the local health and hygiene standards for the environments being used for the production of food. The first and most effective form of preventive maintenance is to keep the machine clean. Careful and regular cleaning prevents the formation of mixture residues which, in the long term, could damage moving parts.

##### Cleaning the external body of the machine

The external body of the machine must be cleaned using only a damp cloth previously immersed in water and sufficiently wrung out. The cloth must be chosen and sanitised as specified by the local hygienic-sanitary standards relating to the environments being used for the production of food. For cleaning, it is absolutely forbidden to use tools that can scratch or damage the machine.

##### Cleaning the inside of the bowl and the kneading tools

Remove any dough residues with a dedicated scratch-resistant tool that does not damage the internal surface of the bowl and the kneading tools. Clean the bowl with water and, if necessary, with food soap. Rinse the bowl well and sanitise it as specified by the local health and hygiene standards relating to the environments used for the production of food.

##### Cleaning the PETG cover

The PETG cover has been designed for food production, and it is therefore essential that it be cleaned and sanitized thoroughly. For proper cleaning, it is recommended to use lukewarm water, with a temperature below 50°C, containing a neutral soap. Rinse with lukewarm water and dry with a cloth. Cleaning and sanitizing using professional dishwashers is not recommended.

## 9 Demolition and disposal



### WARNING

CONSULT THE LEGISLATION IN FORCE IN THE COUNTRY OF THE USER RELATING TO DEMOLITION TO ASCERTAIN ANY PROCEDURES FOR THE "RESPONSIBLE BODY INSPECTION" OR "DOCUMENTATION" TO BE ACTIVATED.



### WARNING

DURING THE PERIODS IN WHICH THE MACHINE IS PUT OUT OF OPERATION FOR EXTENDED TIMES AWAITING DISMANTLING, IT IS APPROPRIATE TO CORDON OFF THE AREA AND SIGNAL THE PROHIBITION OF ACCESS TO UNAUTHORISED PERSONS.

The machine was built with materials that do not present, at the time of demolition, particular aspects of danger for the operator.

The operator or persons assigned to disposal must take into consideration the fact that the materials of which the machine is made are not of a dangerous nature and essentially consist of steel, stainless steel; cast iron, copper, aluminium, electric motors, plastic, electric cables with relative sheaths and rubber seals.

In the event of demolition and disposal of the machine, the operator must take all the necessary precautions to avoid the generation of risks associated with dismantling of the equipment, in accordance with what is prescribed in the chapter 0.

In particular, special precautions must be taken during the phases of:

- Dismantling and removal of the machine from the operating area.
- Transportation and handling.
- Separation of materials.

The operator must manage the waste (i.e. the substance or object which the holder disposes of or has decided or has the obligation to discard) as required by the EU directives 91/156/EEC on waste, 91/689/EEC on hazardous waste and 94/62/EC on packaging and packaging waste so that the waste can be recovered or disposed of without endangering human health and without using procedures or methods that could harm the environment, in particular:

- without causing risks for water, air, soil, fauna and flora;
- without causing problems due to noise or odours;
- without damaging the landscape and sites of particular interest, protected according to current legislation.



### WARNING

ALL MATERIAL USED FOR PACKAGING MUST BE RECOVERED AND DISPOSED OF IN COMPLIANCE WITH THE LAW PROVISIONS DEFINED FOR THE TYPE OF MATERIAL, IN COMPLIANCE WITH THE LAWS IN FORCE, FOR SAFEGUARDING AND PROTECTION OF THE ENVIRONMENT.



### DISPOSAL OF ELECTRICAL AND ELECTRONIC EQUIPMENT (WEEE) SUBJECT TO THE ROHS DIRECTIVE

ELECTRICAL AND ELECTRONIC EQUIPMENT (WEEE) DISPLAYING THIS SYMBOL MUST BE SUBJECT TO DIFFERENTIATED COLLECTION.



MACHINE

SPIRAL

L10 / L22 / LR22 / L33 / LR33 / LR42 / L42

/ L53 / L62





MACHINE

SPIRAL

L10 / L22 / LR22 / L33 / LR33 / LR42 / L42

/ L53 / L62

Electrolux Professionnel SAS  
Z.I du Mont - 23200 AUBUSSON - FRANCE  
[www.electroluxprofessional.com](http://www.electroluxprofessional.com)